



PROTEKTOR-System
Wheelchair and occupant restraints



AMF-Bruns has been developing and manufacturing retractor systems for many years before all the other suppliers of restraint systems entered the market. The first 4 point system for wheelchairs and occupants was sold in the 1970's. At that time AMF-Bruns invented a wheelchair retractor to tighten the wheelchair, it was 20 years later, that others followed AMF-Bruns idea. Meanwhile the PROTEKTOR® system sets the standard worldwide - often copied, but never equalled! Of course, this knowledge and know how is still reflected in our actual restraint system.

New developments like the wheelchair adapter PROSAFE®, the monosystem, are subsequent developments of our actual system and, of course, totally compatible.

Like these, the PROTEKTOR® system gets even more easy, faster and safer to use, than any other product on the market.

To ensure ultimate safety AMF-Bruns goes further. - Good is not good enough for us!

AMF-Bruns is the world's leading company for webbing safety systems for wheelchairs and occupants. Production follows the strict rules of the ISO 9001 standard.

On top of this AMF-Bruns works permanently in different national & international meetings, has their own testing facilities and, also test at organisations like TÜV, BAST, DTC, UTAC.

The result is a proven, ultimately safe system, which meets all the requirements of its users, the PROTEKTOR® system.

standards

The AMF-Bruns PROTEKTOR® System fullfills, for example, ISO 10542-1 + 2, DIN 75078-2, CSA Z 605, FMSS/CNVSS, AS 2596, SAE J 49, 2001/85/ EC.

SAFE DIVERSITY

The PROTEKTOR® occupant and wheelchair restraint system offers a number of variations.

For the installation to the vehicle floor the PROTEKTOR® System offers 4 stud fitting and mono fitting.

For the fortification on the wheelchair the system offers loops, hooks or carabiners.

Whether you use the manual **BLACKSERIES** or the automatic **SILVERSERIES**, the PROTEKTOR® System offers proven safety according to ISO 10542, regardless of what variations you choose.

Simply choose the System that best suits your needs.





BLACKSERIES

- manual pull-out and semi automatic self-tensioning system
- lightweight ABS-Cover



PROTEKTOR-System

BLACKSERIES

RETRACTOR SYSTEM WITH LOOP

4 STUD FITTING AT 40°, FLEXIBLE



**Protector®-System
Pro 2 B LV with loop
and 4 stud fitting at 40°, flexible**

- 2 x retractor belt LV
- 2 x static belt LV
- 1 x pelvis belt

Item-No. H 350 502 LV

7

**Protector®-System
Pro 4 B LV with loop
and 4 stud fitting at 40°, flexible**

- 4 x retractor belt LV
- 1 x pelvis belt

Item-No. H 350 504 LV

4 STUD FITTING TWISTED 40/90°, FLEXIBLE

**Protector®-System
Pro 2 B LG with loop and 4 stud
fitting twisted 40/90°, flexible**

- 2 x retractor belt LG
- 2 x static belt LV
- 1 x pelvis belt

Item-No. H 350 502 LG

**Protector®-System
Pro 4 B LG with loop and 4 stud
fitting twisted 40/90°, flexible**

- 4 x retractor belt LG
- 1 x pelvis belt

Item-No. H 350 504 LG

4 STUD FITTING FLAT FLEXIBLE



Protector®-System
Pro 2 B LF with loop and 4 stud fitting, flat flexible

- 2 x retractor belt LF
- 2 x static belt LV
- 1 x pelvis belt

Item-No. H 350 502 LF

MONO FITTING AT 40°

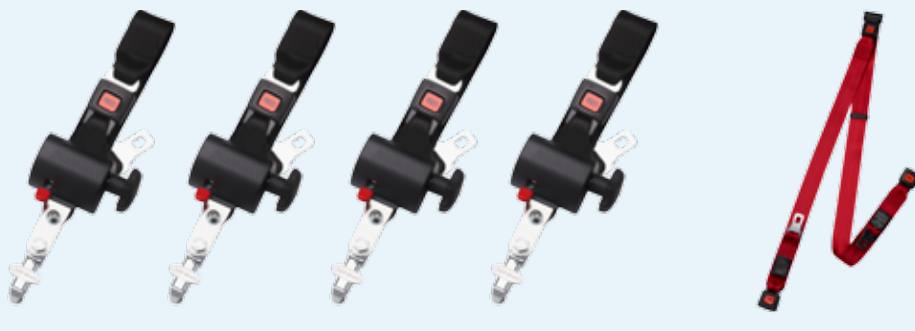

Protector®-System
Pro 4 B LF with loop and 4 stud fitting, flat flexible

- 4 x retractor belt LF
- 1 x pelvis belt

Item-No. H 350 504 LF

MONO FITTING AT 40°



Protector®-System
Pro 2 B LM with loop and Mono fitting at 40°

- 2 x retractor belt LM
- 2 x static belt LM
- 1 x pelvis belt

Item-No. H 350 502 LM

MONO FITTING AT 40°



Protector®-System
Pro 4 B LM with loop and Mono fitting at 40°

- 4 x retractor belt LM
- 1 x pelvis belt

Item-No. H 350 504 LM

RETRACTOR SYSTEM WITH HOOK

4 STUD FITTING AT 40°, FLEXIBLE



Protector®-System
Pro 2 B HV with hook and 4 stud fitting at 40°, flexible

- 2 x retractor belt HV
- 2 x static belt HV
- 1 x pelvis belt

Item-No. H 350 522 HV

4 STUD FITTING AT 40°, FLEXIBLE



Protektor®-System
Pro 4 B HV with hook and
4 stud fitting at 40°, flexible

- 4 x retractor belt HV
- 1 x pelvis belt

Item-No. H 350 524 HV

4 STUD FITTING TWISTED AT 40/90°, FLEXIBLE



Protektor®-System
Pro 2 B HG with hook and
4 stud fitting twisted 40/90°, flexible

- 2 x retractor belt HG
- 2 x static belt HV
- 1 x pelvis belt

Item-No. H 350 522 HG

7



Protektor®-System
Pro 4 B HG with hook and
4 stud fitting twisted 40/90°, flexible

- 4 x retractor belt HG
- 1 x pelvis belt

Item-No. H 350 524 HG



Protektor®-System
Pro 2 B HF with hook and
4 stud fitting, flat flexible

- 2 x retractor belt HF
- 2 x static belt HV
- 1 x pelvis belt

Item-No. H 350 522 HF



Protektor®-System
Pro 4 B HF with hook and
4 stud fitting, flat flexible

- 4 x retractor belt HF
- 1 x pelvis belt

Item-No. H 350 524 HF

4 STUD FITTING FLAT FLEXIBLE



**Protektor®-System
Pro 2 B HM with hook and
Mono fitting at 40°**

- 2 x retractor belt HM
- 2 x static belt HM
- 1 x pelvis belt

Item-No. H 350 522 HM



**Protektor®-System
Pro 4 B HM with hook
and Mono fitting at 40°**

- 4 x retractor belt HM
- 1 x pelvis belt

Item-No. H 350 524 HM

RETRACTOR SYSTEM WITH CARABINER

4 STUD FITTING FLAT FLEXIBLE



**Protektor®-System
Pro 2 B CV with carabiner
and 4 stud fitting at 40°, flexible**

- 2 x retractor belt CV
- 2 x static belt CV
- 1 x pelvis belt

Item-No. H 350 552 CV



**Protektor®-System
Pro 4 B CV with carabiner
and 4 stud fitting at 40°, flexible**

- 4 x retractor belt CV
- 1 x pelvis belt

Item-No. H 350 554 CV

4 STUD FITTING 40/90°, FLEXIBLE



**Protektor®-System
Pro 2 B CG with carabiner and
4 stud fitting twisted 40/90°, flexible**

- 2 x retractor belt CG
- 2 x static belt CV
- 1 x pelvis belt

Item-No. H 350 552 CG

4 STUD FITTING TWISTED AT 40/90°, FLEXIBLE



Protektor®-System
Pro 4 B CG with carabiner
and 4 stud fitting twisted 40/90°,
flexible

- 2 x retractor belt CG
- 2 x static belt CV

Item-No. H 350 554 CG

4 STUD FITTING FLAT FLEXIBLE



Protektor®-System
Pro 2 B CF with carabiner
and 4 stud fitting, flat flexible

- 2 x retractor belt CF
- 2 x static belt CV
- 1 x pelvis belt

Item-No. H 350 552 CF



Protektor®-System
Pro 4 B CF with carabiner
and 4 stud fitting, flat flexible

- 4 x retractor belt CF
- 1 x pelvis belt

Item-No. H 350 554 CF

MONO FITTING 40°



Protektor®-System
Pro 2 B CM with carabiner
and Mono fitting at 40°

- 2 x retractor belt CM
- 2 x static belt CM
- 1 x pelvis belt

Item-No. H 350 552 CM



Protektor®-System
Pro 4 B CM with carabiner
and Mono fitting at 40°

- 4 x retractor belt CM
- 1 x pelvis belt

Item-No. H 350 554 CM

7

RETRACTOR WITH LOOP



Retractor B LV
with loop and
4 stud fitting at 40°,
flexible

Item-No.
H 350 509 LV



Retractor B LG
with loop and
4 stud fitting
twisted 40/90°,
flexible

Item-No.
H 350 509 LG



Retractor B LF
with loop and
4 stud fitting,
flat flexible

Item-No.
H 350 509 LF



Retractor B LM
with loop and
Mono fitting at 40°

Item-No.
H 350 509 LM

RETRACTOR WITH HOOK



Retractor B HV
with hook and
4 stud fitting
at 40°, flexible

Item-No.
H 350 534 HV



Retractor B HG
with hook and
4 stud fitting
twisted 40/90°, flexible

Item-No.
H 350 534 HG



Retractor B HF
with hook and
4 stud fitting
flat flexible

Item-No.
H 350 534 HF



Retractor B HM
with hook and
Mono fitting at 40°

Item-No.
H 350 534 HM

RETRACTOR WITH CARABINER



Retractor B CV
with carabiner and
4 stud fitting
at 40°, flexible

Item-No.
H 350 564 CV



Retractor B CG
with carabiner and
4 stud fitting twisted
40/90°, flexible

Item-No.
H 350 564 CG



Retractor B CF
with carabiner and
4 stud fitting,
flat flexible

Item-No.
H 350 564 CF



Retractor B CM
with carabiner and
Mono fitting at 40°

Item-No.
H 350 564 CM

STATIC BELTS

STATIC BELT WITH 4 STUD FITTING



Static belt LV with loop and 4 stud fitting (front attachment)

Item-No.
H 350 510 LV



Static belt HV with hook and 4 stud fitting (front attachment)

Item-No.
H 350 535 HV



Static belt CV with carabiner and 4 stud fitting (front attachment)

Item-No.
H 350 565 CV

STATIC BELTS

STATIC BELT WITH MONO FITTING



Static belt LM with loop and Mono fitting (front attachment)

Item-No.
H 350 510 LM



Static belt HM with hook and Mono fitting (front attachment)

Item-No.
H 350 535 HM



Static belt CM with carabiner and Mono fitting (front attachment)

Item-No.
H 350 565 CM

ELECTRIC BELTS



Electric belt L with loop, length 3,6 m (front attachment)

Item-No.
H 350 240 L



Electric belt H with hook, length 3,6 m (front attachment)

Item-No.
H 350 240 H

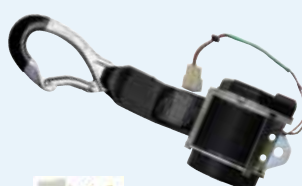

Electric belt C with carabiner, length 3,6 m (front attachment)

Item-No.
H 350 240 C



Cover complete
for electric belt
(front attachment)

Item-No.
H 350 634



Cover
for electric belt
(front attachment)

Item-No.
H 350 632



Cover floor
for electric belt
(front attachment)

Item-No.
H 350 633



7



SILVERSERIES

- fully automatic pull-out and self-tensioning system
- robust zinc diecasting cover



PROTEKTOR-System

SILVERSERIES

WHEELCHAIR RESTRAINT SYSTEM

General note!
Static belt only for front attachment.

RETRACTOR SYSTEM WITH LOOP

4 STUD FITTING AT 40°, FLEXIBLE



Protektor®-System
Pro 2 S LV with loop
and 4 stud fitting
at 40°, flexible

- 2 x retractor belt LV
- 2 x static belt LV
- 1 x pelvis belt

Item-No. H 350 501 LV



Protektor®-System
Pro 4 S LV with loop
and 4 stud fitting
at 40°, flexible

- 4 x retractor belt LV
- 1 x pelvis belt

Item-No. H 350 503 LV

4 STUD FITTING TWISTED 40/90°, FLEXIBLE



Protektor®-System
Pro 2 S LG with loop
and 4 stud fitting twisted
40/90°, flexible

- 2 x retractor belt LG
- 2 x static belt LV
- 1 x pelvis belt

Item-No. H 350 501 LG

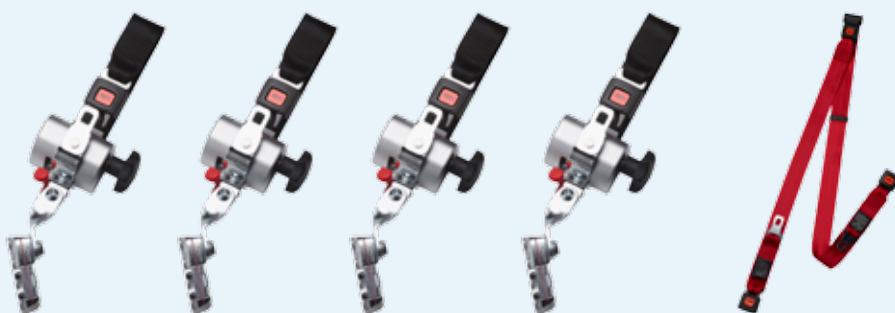

Protektor®-System
Pro 4 S LG with loop
and 4 stud fitting twisted
40/90°, flexible

- 4 x retractor belt LG
- 1 x pelvis belt

Item-No. H 350 503 LG

4 STUD FITTING, FLAT FLEXIBLE



Protector®-System
Pro 2 S LF with loop
and 4 stud fitting,
flat flexible

- 2 x retractor belt LF
- 2 x static belt LV
- 1 x pelvis belt

Item-No. H 350 501 LF

Protector®-System
Pro 4 S LF with loop
and 4 stud fitting,
flat flexible

- 4 x retractor belt LF
- 1 x pelvis belt

Item-No. H 350 503 LF

MONO FITTING AT 40°



Protector®-System
Pro 2 S LM with loop
and Mono fitting at 40°

- 2 x retractor belt LM
- 2 x static belt LM
- 1 x pelvis belt

Item-No. H350 501 LM

Protector®-System
Pro 4 S LM with loop
and Mono fitting at 40°

- 4 x retractor belt LM
- 1 x pelvis belt

Item-No. H 350 503 LM

RETRACTOR SYSTEM WITH HOOK

4 STUD FITTING 40°, FLEXIBLE



Protector®-System
Pro 2 S HV with hook
and 4 stud fitting
at 40°, flexible

- 2 x retractor belt HV
- 2 x static belt HV
- 1 x pelvis belt

Item-No. H 350 520 HV

4 STUD FITTING 40°, FLEXIBLE



Protektor®-System
Pro 4 S HV with hook
and 4 stud fitting
at 40°, flexible

- 4 x retractor belt HV
- 1 x pelvis belt

Item-No. H350 525 HV

4 STUD FITTING TWISTED 40/90°, FLEXIBLE



Protektor®-System
Pro 2 S HG with hook
and 4 stud fitting twisted
40/90°, flexible

- 2 x retractor belt HG
- 2 x static belt HV
- 1 x pelvis belt

Item-No. H 350 520 HG

7

4 STUD FITTING TWISTED 40/90°, FLEXIBLE



Protektor®-System
Pro 4 S HG with hook
and 4 stud fitting twisted
40/90°, flexible

- 4 x retractor belt HG
- 1 x pelvis belt

Item-No. H 350 525 HG

4 STUD FITTING, FLAT FLEXIBLE



Protektor®-System
Pro 2 S HF with hook
and 4 stud fitting,
flat flexible

- 2 x retractor belt HF
- 2 x static belt HV
- 1 x pelvis belt

Item-No. H 350 520 HF

4 STUD FITTING, FLAT FLEXIBLE



Protektor®-System
Pro 4 S HF with hook
and 4 stud fitting,
flat flexible

- 4 x retractor belt
- 1 x pelvis belt

Item-No. H 350 525 HF

MONO FITTING AT 40°



Protektor®-System
Pro 2 S HM with hook
and Mono fitting at 40°

- 2 x retractor belt HM
- 2 x static belt HM
- 1 x pelvis belt

Item-No. H 350 520 HM



Protektor®-System
Pro 4 S HM with hook
and Mono fitting at 40°

- 4 x retractor belt HM
- 1 x pelvis belt

Item-No. H 350 525 HM

RETRACTOR SYSTEM WITH CARABINER

4 STUD FITTING 40°, FLEXIBLE



Protektor®-System
Pro 2 S CV with carabiner
and 4 stud fitting at 40°, flexible

- 2 x retractor belt CV
- 2 x static belt CV
- 1 x pelvis belt

Item-No. H 350 550 CV



Protektor®-System
Pro 4 S CV with carabiner
and 4 stud fitting at 40°,
flexible

- 4 x retractor belt CV
- 1 x pelvis belt

Item-No. H350 555 CV

4 STUD FITTING TWISTED 40/90°, FLEXIBLE



Protektor®-System
Pro 2 S CG with carabiner
and 4 stud fitting twisted
40/90°, flexible

- 2 x retractor belt CG
- 2 x static belt CV
- 1 x pelvis belt

Item-No. H 350 550 CG

4 STUD FITTING TWISTED 40/90°, FLEXIBLE



Protektor®-System
Pro 4 S CG with carabiner
and 4 stud fitting twisted
40/90°, flexible

- 4 x retractor belt CG
- 1 x pelvis belt

Item-No. H 350 555 CG

4 STUD FITTING, FLAT FLEXIBLE



Protektor®-System
Pro 2 S CF with carabiner
and 4 stud fitting,
flat flexible

- 2 x retractor belt CF
- 2 x static belt CV
- 1 x pelvis belt

Item-No. H 350 555 CF

7



Protektor®-System
Pro 4 S CF with carabiner
and 4 stud fitting,
flat flexible

- 4 x retractor belt CF
- 1 x pelvis belt

Item-No. H 350 555 CF

MONO FITTING AT 40°



Protektor®-System
Pro 2 S CM with carabiner
and Mono fitting at 40°

- 2 x retractor belt CM
- 2 x static belt CM
- 1 x pelvis belt

Item-No. H 350 555 CM



Protektor®-System
Pro 4 CM with carabiner
and Mono fitting at 40°

- 4 x retractor belt CM
- 1 x pelvis belt

Item-No. H 350 555 CM

RETRACTOR WITH LOOP



Retractor S LV
with loop and
4 stud fitting
at 40°, flexible

Item-No.
H 350 505 LV



Retractor S LG
with loop and
4 stud fitting
twisted 40/90°, flexible

Item-No.
H 350 505 LG



Retractor S LF
with loop and
4 stud fitting,
flat flexible

Item-No.
H 350 505 LF



Retractor S LM
with loop
and Mono fitting
at 40°

Item-No.
H 350 505 LM

RETRACTOR WITH HOOK

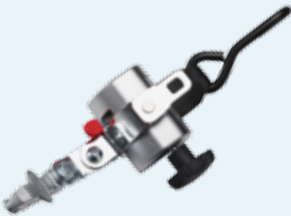

Retractor S HV
with hook and
4 stud fitting
flexible at 40°

Item-No.
H 350 530 HV



Retractor S HG
with hook and
4 stud fitting
twisted, 40/90°, flexible

Item-No.
H 350 530 HG



Retractor S HF
with hook and
4 stud fitting,
flat flexible

Item-No.
H 350 530 HF



Retractor S HM
with hook
and Mono fitting
at 40°

Item-No.
H 350 530 HM

RETRACTOR WITH CARABINER

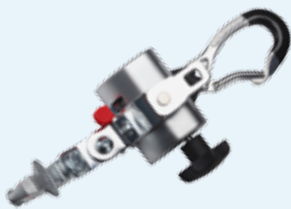

Retractor S CV
with carabiner and
4 stud fitting
flexible at 40°

Item-No.
H 350 560 CV



Retractor S CG
with carabiner and
4 stud fitting
twisted 40/90°, flexible

Item-No.
H 350 560 CG

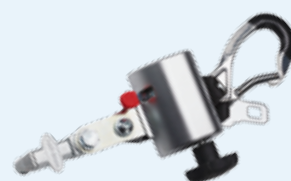

Retractor S CF
with carabiner and
4 stud fitting,
flat flexible

Item-No.
H 350 560 CF



Retractor S CM
with carabiner
and Mono fitting
at 40°

Item-No.
H 350 560 CM

STATIC BELTS

STATIC BELT WITH 4 STUD FITTING



Static belt LV
with loop
and 4 stud fitting
(front attachment)

Item-No.
H 350 510 LV



Static belt HV
with hook
and 4 stud fitting
(front attachment)

Item-No.
H 350 535 HV



Static belt CV
with carabiner
and 4 stud fitting
(front attachment)

Item-No.
H 350 565 CV

STATIC BELTS

STATIC BELT WITH MONO FITTING



Static belt LM
with loop
and Mono fitting
(front attachment)

Item-No.
H 350 510 LM



Static belt HM
with hook
and Mono fitting
(front attachment)

Item-No.
H 350 535 HM



Static belt CM
with carabiner
and Mono fitting
(front attachment)

Item-No.
H 350 565 CM

ELECTRIC BELTS



Electric belt L
with loop,
length 3,6 m
(front attachment)

Item-No.
H 350 240 L

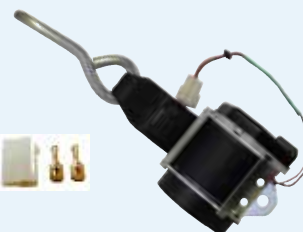

Electric belt H
with hook,
length 3,6 m
(front attachment)

Item-No.
H 350 240 H



Electric belt C
with carabiner,
length 3,6 m
(front attachment)

Item-No.
H 350 240 C



Cover complete
for electric belt
(front attachment)

Item-No.
H 350 634



Cover
for electric belt
(front attachment)

Item-No.
H 350 632



Cover floor
for electric belt
(front attachment)

Item-No.
H 350 633





Accessories



OCCUPANT RESTRAINT SYSTEM



Pelvis belt
Standard length
Item-No.
H 350 200

XL Version
Item-No.
H 350 198



Automatic pelvis belt with flexible buckle

Item-No.
H 350 205



Automatic pelvis belt

Item-No.
H 350 207



Flexible buckle length 300 mm

Item-No.
H 350 210



Automatic shoulder belt without height adjustment

Item-No.
H 350 225



Automatic shoulder belt (height adjustable)

Item-No.
H 350 235



Automatic shoulder belt without height adjustment incl. two 4 stud fittings

Item-No.
H 350 250



Automatic shoulder belt with height adjustment incl. two 4 stud fittings

Item-No.
H 350 239



Static shoulder belt

Item-No.
H 350 226



Static shoulder belt with buckle, two part

Item-No.
H 350 227

OCCUPANT RESTRAINT SYSTEM



Automatic 3-Point-Belt with height adjustment incl. tongue

Item-No. H 350 231



Automatic 3 point belt without height adjustment

Item-No. H 350 230



Automatic 3-Point-Belt without height adjustment incl. two 4 stud fittings

Item-No. H 350 251



Automatic 3-Point-Belt with height adjustment incl. two 4 stud fittings

Item-No. H 350 252



WAV Automatic 3-Point-Belt with height adjustment and two flexible buckles, 300 mm

Item-No. H 350 233



WAV Automatic 3-Point-Belt without height adjustment and two flexible buckles, 300 mm

Item-No. H 350 232



Harnessbelt (only in combination with shoulder belt)

Item-No. 350 222



Easy-Bag for restraint system

Item-No. 10019363

ACCESSORIES



Headrest

W 330 - 410 mm
Item-No. H 150 259

W 400 - 480 mm
Item-No. H 150 258



Secure belt 300 mm

Item-No. H 350 238

ACCESSORIES

Floor pocket

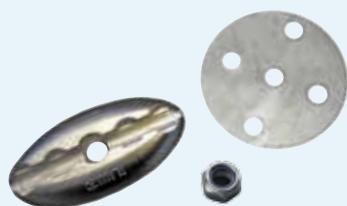

Item-No.
200269390

Breast belt



180 cm length Item-No. H 150 222
 160 cm length Item-No. H 150 223
 110 cm length Item-No. H 150 224

FLOOR SYSTEMS



Protaktor® Surface track

not predrilled
 1000 mm length Item-No. H 150 132
 1500 mm length Item-No. H 150 134
 1750 mm length Item-No. H 150 135
 3000 mm length Item-No. H 150 136

predrilled
 3000 mm length Item-No. H 150 385



Protaktor® Insert track

not predrilled
 1750 mm length Item-No. H 150 120
 3500 mm length Item-No. H 150 130

predrilled
 3500 mm length Item-No. H 150 375



Mono fitting
(complete)

Item-No.
H 150 915
with Bolt M12
50 mm



Mono fitting
(head piece)

Item-No.
H 150 916
with Bolt M12
50 mm



Monodisc (floor)
 Item-No. H 150 917
 with Bolt M12 50 mm



Mono fitting with 40°
 Item-No. H 150 619



4 stud fitting
 Item-No. 2002 11247



4 stud fitting with bolt
 Item-No. H 150 615



4 stud fitting 40° bracket
 Item-No. H 150 616



4 stud fitting twisted 40°/90°
 Item-No. H 150 617



4 stud fitting flat
 Item-No. H 150 618



End cap for surface track
 Item-No. 200 261 878



End cap for insert track
 Item-No. 200 261 840

Protector
Head and Back rest/seat belt anchorage



7



Back and head support

Smartfloor includes two special back and head support constructions to provide the best possible protection of the back and head of a wheelchair occupant in the event of an accident during transport. Both constructions are suitable for mounting to the floor in an airline rail and flexible in their application at any desired location in the vehicle.

Fixed third belt point

Smartfloor delivers a special 3-point shoulder belt for vehicles that are fitted with an airline guide rail mounted in the top side of the vehicle. By means of this rail, a third belt point can be easily created throughout the interior of the vehicle. The advantage is that the vehicle, in combination with a Smartfloor, meets ISO 10542 standards. Delivery options include either a fixed belt or an auto-retractable belt.

Standard sets

Smartfloor supplies the AMF Protektor in standard sets inclusive of a red, static hip belt. Depending on the options selected, the sets are fitted with either 2 or 4 retractors, safety belt lock or stainless steel open hooks for attachment to the wheelchair. Options further include a static 3-point shoulder belt or a 3-point auto-retractable shoulder belt. For a complete list of all available sets, see the table on the next page.

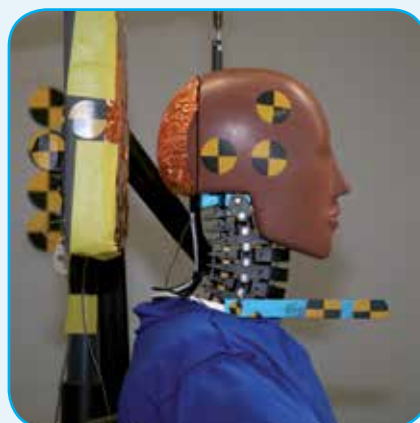

RAIL SOLUTION

VEHICLE APPROVED ANCHORAGE POINTS FOR OCCUPANT RESTRAINTS

New EU directive 2007/46/EG (214/2014 Annex XI, 3) – already mandatory in some European countries

UPPER ANCHORAGE POINTS

All AMF-Bruns occupant restraint systems – whether static or automatic shoulder belts in combination with a separate pelvis belt or integrated 3 point belt – have been tested with 24.5 kN forwards and 8.2 kN backwards. AMF-Bruns has developed and produces special assembly kits for each vehicle. The pull tests are carried out in our own test centre in cooperation with TÜV. The assembly kits are compatible with all AMF-Bruns restraint systems.

AMF-BRUNS PROTEKTOR® WHEELCHAIR AND OCCUPANT RESTRAINT SYSTEM FULFILLS THE NEW EU DIRECTIVE 2007/46/EG WHICH CAME INTO FORCE ON 1ST NOVEMBER 2014.

ATTENTION!

The vehicle manufacturer’s body fitting guidelines must be adhered to and AMF-Bruns original parts need to be used for the installation!

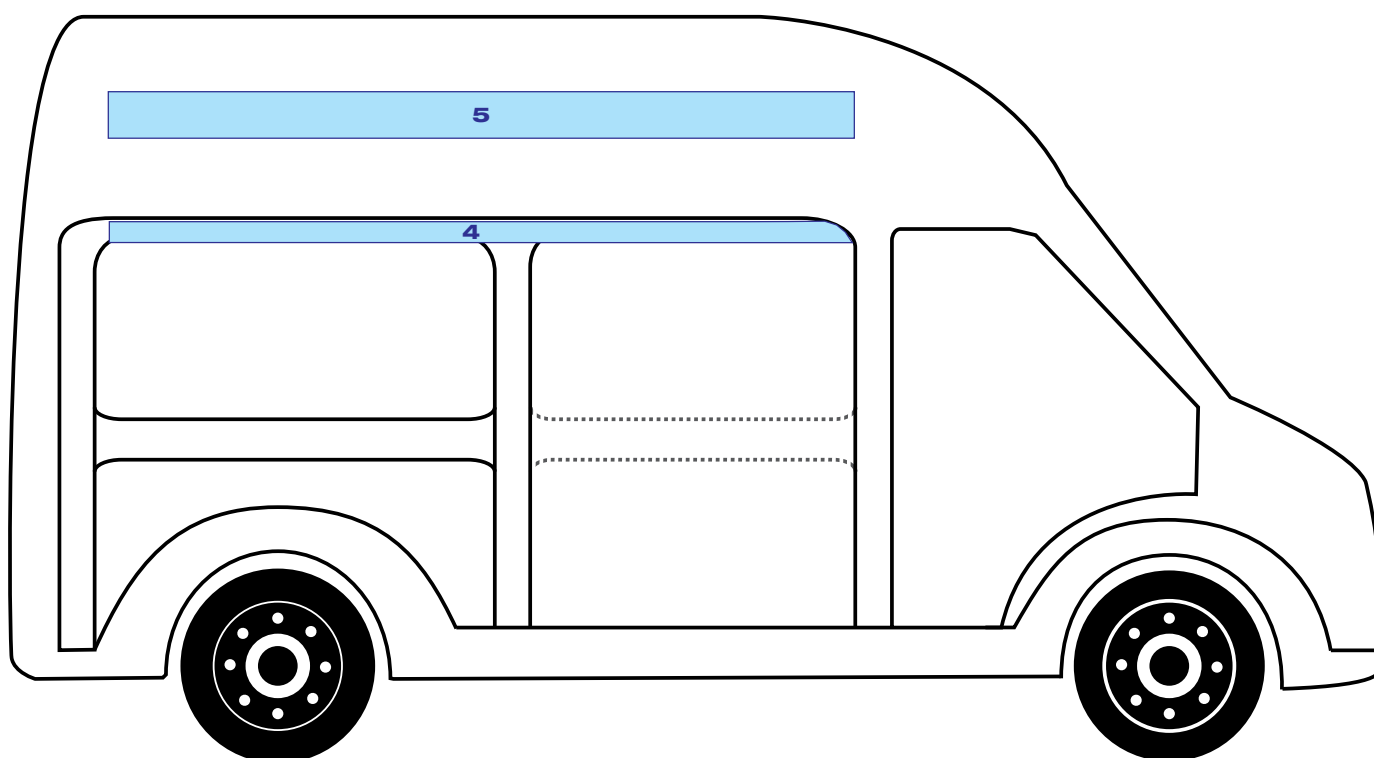

Vehicle Model without Trim	Area	Assembly material Mounting rail 1 m	Assembly material Mounting rail 3 m	Mounting rail 1 m	Mounting rail 3 m
Peugeot Boxer / Fiat Ducato Citroen Jumper	4	1001 9571	1001 9572	H150 132	H150 136
Ford Transit	4	1001 9578	1001 9579	H150 132	H150 136
Nissan NV400 / Opel Movano	4	1001 9578	1001 9579	H150 132	H150 136
Renault Master	5	1001 9578	1001 9579	H150 132	H150 136
Volkswagen Crafter Mercedes-Benz Sprinter	4	1001 9680	1001 9681	H150 132	H150 136

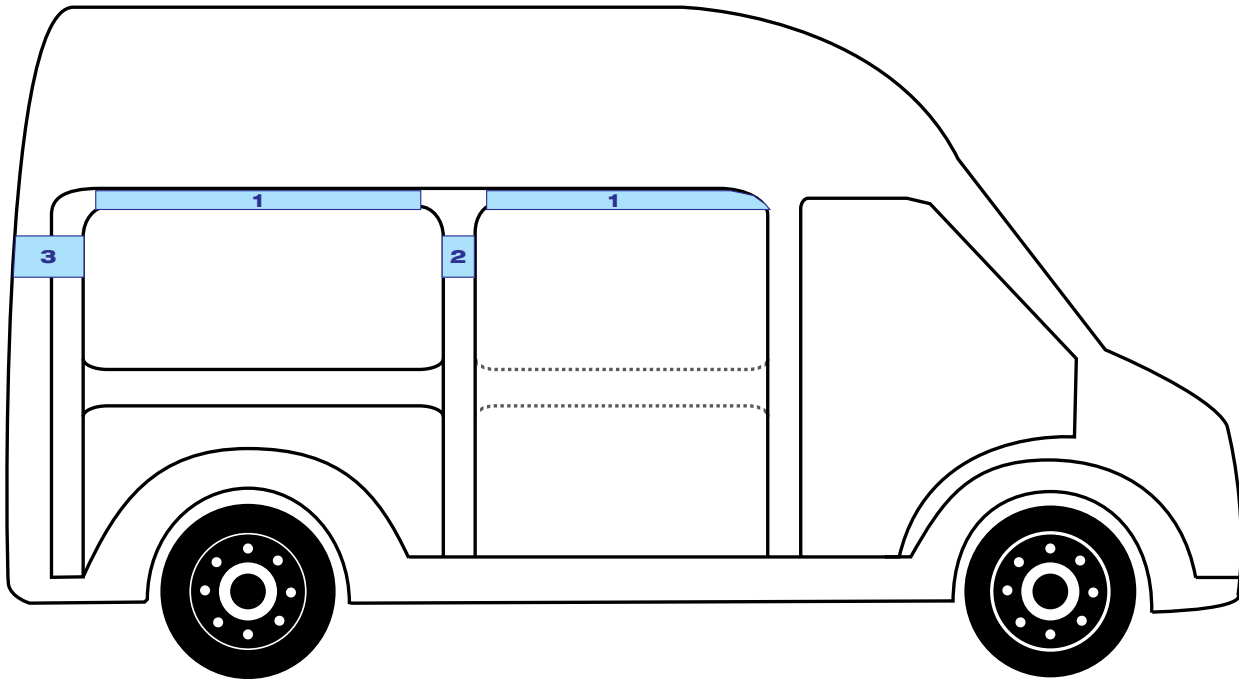

Vehicle Model	Area	Part No. with Trim	Part No. without Trim
Peugeot Boxer/ Fiat Ducato	1	1001 9565	1001 9564
Citroen Jumper	2	1001 9564	1001 9564
	3	1001 9563	1001 9562
	1	1001 9665	1001 9665
Ford Transit	2	1001 9574	1001 9574
	3	1001 9564	1001 9564
	1	1001 9564	1001 9564
Ford Transit Custom	2	1001 9573	1001 9573
	3	1001 9574	1001 9574
	1	-	-
Mercedes-Benz Vito	2	1001 9679	1001 9679
	3	1001 9678	1001 9679
	1	1001 9676	1001 9676
Volkswagen Crafter	1	1001 9676	1001 9676
Mercedes-Benz Sprinter	2	-	-
	3	-	-
	1	1001 9564	1001 9564
Nissan NV300 / Opel Vivaro	2	1001 9564	1001 9564
	3	1001 9574	1001 9574
	1	1001 9577	1001 9576
Nissan NV400 / Opel Movano	2	1001 9564	1001 9564
	3	1001 9562	1001 9562
	1*	1001 9574	1001 9574
Volkswagen T5/T6	2	1001 9574	1001 9574
	3**	1001 9574	1001 9574

* Only Transporter and Combi

** At this moment not obtainable for T6. Available soon.

SMARTFLOOR

Flexibility inside

Netherlands, Belgium and Luxembourg

SMARTFLOOR B.V.
Veldkampsweg 26
7605 AR Almelo
Nederland
Telefoon : +31 546 45 55 65
www.smartfloor.nl
info@smartfloor.nl

United Kingdom

AMF-Bruns UK LTD
Unit 3, Parkway Four
Longbridge Road
Trafford Park
Manchester
M17 1SW
Tel. +44 161 872 7951
www.amf-bruns.com
info@amf-bruns.co.uk

United States of America

AMF-Bruns of America
1797 Georgetown Road
Hudson · OH 44236
Phone +1 877 506 3770
www.amfbrunsamerica.com

Germany

AMF-Bruns Gustav Bruns GmbH & Co. KG
Hauptstraße 101
D-26689 Apen
Postfach 160
D-26689 Apen
Tel. +49 44 89 72 71 01
www.amf-bruns.de
hubmatik@amf-bruns.de

Asia

Smartfloor Seating (Thailand) Co. Ltd
Kunwang Place 165/86
T.:Sanrapao A.: Sansai
Chiang Mai 50210 Thailand

Middle East & North African Region

AMF-Bruns MENA
Bisco FZCO · Silicon Oasis
LIU4 Units C8 & C9 · Dubai



Member of AMF-Bruns group